

1. Installation

1.1 Select the required components to your workplan.
(Typical items shown below)

Module Types

MediaFlex Inserts

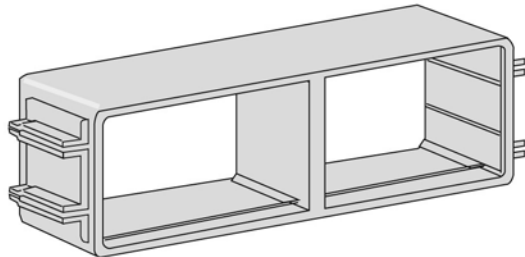

GigaBIX/MediaFlex Adapter

Tool (not included)

Outlet Release Tool: AX101185

UTP modules Multimedia - Coaxial & Fiber

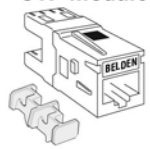

GigaFlex Module



EZ-MDVO Module



Blank Module



MDVO Video F Coaxial Module



MDVO SC Fiber Module



MDVO MT-RJ Fiber Module



S-VHS Insert



RCA Insert



SVGA Insert

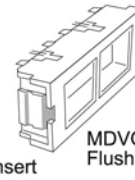

MDVO (Style) Flush Insert

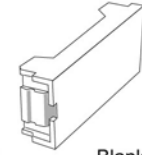

Blank Inserts

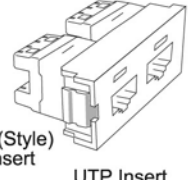

UTP Insert

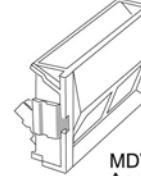

MDVO (Style) Angled Insert

Applications

The GigaBIX/MediaFlex Adapter can be used on all GigaBIX type mounts. The GigaBIX 19" Rack Mount Panel and Adapter application is shown in this document

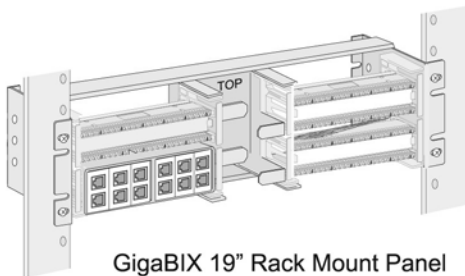

GigaBIX 19" Rack Mount Panel

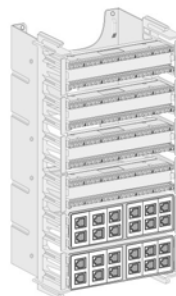

GigaBIX Mount



Note: Install the various modules and inserts as per their respective installation guides.

Related Documents

EZ-MDVO Type Modules
- Refer to PX102753 for terminating procedure.

GigaFlex Type Modules
- Refer to PX103329 for terminating procedure.

Assembly of MediaFlex
- Refer to PX102063 for detailed assembly and servicing procedures.

Termination Station
- Refer to PX103206 for terminating procedures.

1.2 Snap adapter into rack.
Orient side tabs as shown.

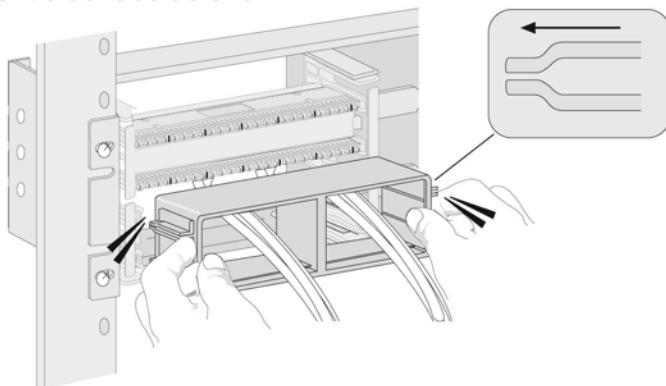

Termination Station



The hand-held Termination Station (part# AX101172) must be used for termination!

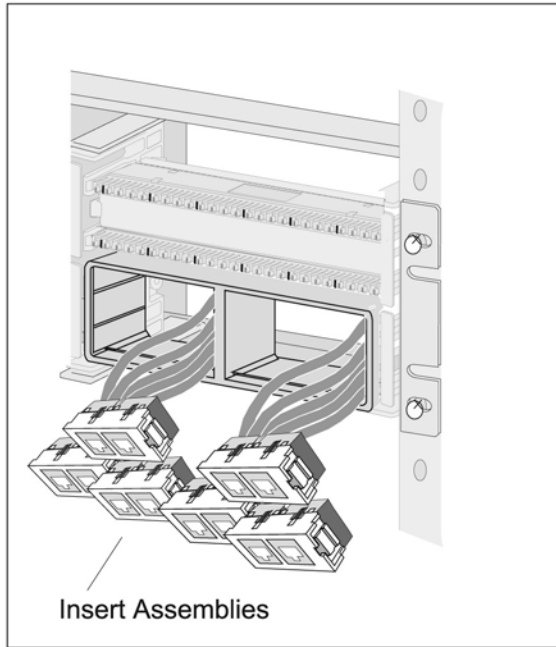

1.3 Snap insert assemblies into adapter.

Note: Install angled inserts in the direction of patch cord routing.

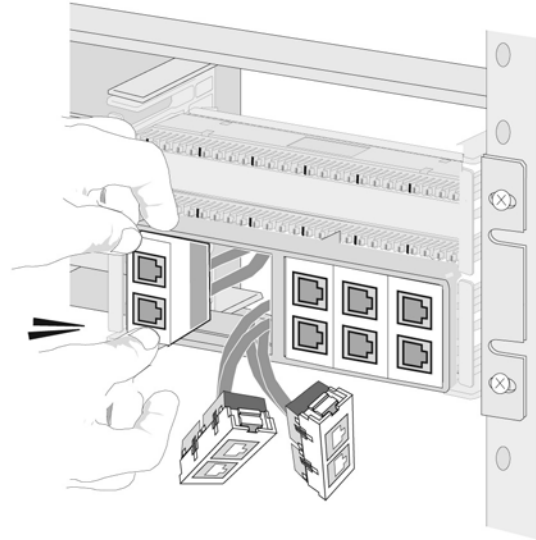

2. MediaFlex Servicing "Front Access"

2.1 Releasing Inserts

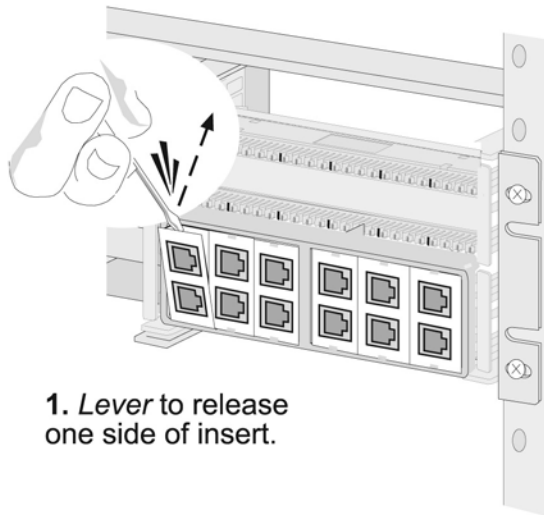
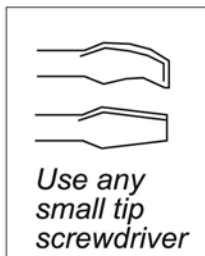

1. Lever to release one side of insert.

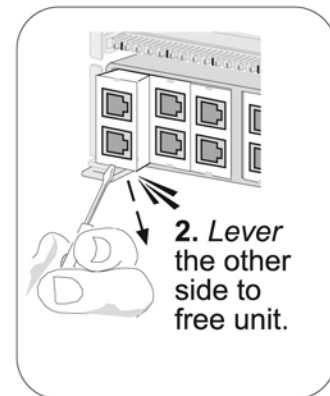

BELDEN

For additional technical information on the GigaBIX/MediaFlex Adapter or our other connectivity products, call our Technical Support department at 1-800-858-7954

GigaBIX